

Varenummer: 2310431044  
Beskrivelse: E+G Stilleben  
LX.40-SW17-M10X50

## Mål

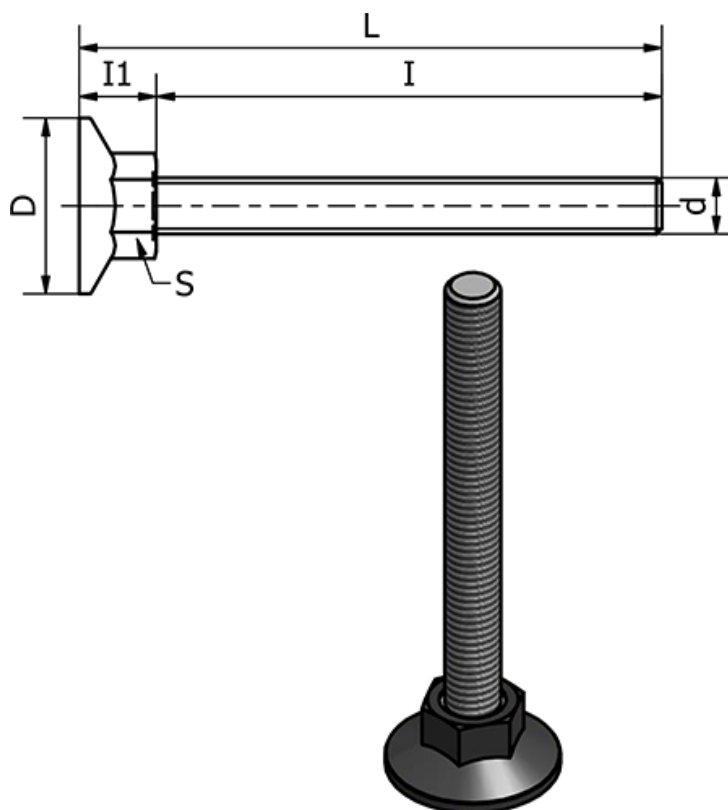

d	= M10
D	= 40
I	= 50
I1	= 13
L	= 62.5
Max statisk belastning (N)	= 3000
S	= 17
Type	= Forzinket

Vægt (g) = -